



# Unleashed T301n Access Point Quick Setup Guide

This *Quick Setup Guide* provides step-by-step instructions on installation and initial setup of the Ruckus Wireless Unleashed T301n 802.11ac outdoor access point (AP). Unless specifically indicated, the rest of this document refers to the Unleashed T301n as an "AP."

For detailed information on configuring and operating the Unleashed network, refer to the *Unleashed Online Help*. To access the Online Help, click the *Help* link from within the Unleashed user interface.

**WARNING:** Only trained and qualified personnel should be allowed to install, replace, or service this equipment.

**WARNING:** Installation of this equipment must comply with local and national electrical codes.

**CAUTION:** Make sure that you form a 80mm - 130mm (3"-5") drip loop in any cable that is attached to the AP or the building. This will prevent water from running along the cable and entering the AP or the building where the cable terminates.

**CAUTION:** Be sure that grounding is available and that it meets local and national electrical codes. For additional lightning protection, use lightning rods and lightning arrestors.

**CAUTION:** Make sure that proper lightning surge protection precautions are taken according to local electrical code.

**WARNING:** Ruckus Wireless strongly recommends that you wear eye protection before mounting the AP.

## THIS GUIDE IN OTHER LANGUAGES

- 请从以下网站获得该指南的简体中文版 <https://support.ruckuswireless.com>.
- Vous trouverez la version française de ce guide à l'adresse suivante <https://support.ruckuswireless.com>.
- このガイドの日本語版は <https://support.ruckuswireless.com> でご覧ください。
- 이 가이드의 한국어 버전은 웹 사이트 (<https://support.ruckuswireless.com>) 에서 확인하시기 바랍니다.
- Veja a versão em português (Brasil) deste guia em <https://support.ruckuswireless.com>.
- Puede ver la versión en español (América Latina) de esta guía en <https://support.ruckuswireless.com>.

## REQUIRED HARDWARE AND TOOLS

- Torque wrench or torque screwdriver with sockets and bits
- Wide flat-blade screwdriver
- Medium flat-blade or No. 2 Phillips screwdriver
- Customer-supplied outdoor-rated Cat5e UTP RJ-45 Ethernet cable with 4.0mm to 6.5mm (0.17" to 0.26") round cable sheath

If you need to lock the mounting bracket to the AP, then you will also need:

- One customer-supplied stainless steel 6mm M3 panhead locking security screw and security screwdriver.

If you are mounting the AP on a flat surface, then you will also need:

- Customer-supplied wall anchors with up to M6 or 0.25" stainless steel screws rated to withstand 128 N or 28.8 lbf (required to withstand wind loads of 266km/h or 165mph)

**NOTE:** The screw head/washer combination shall not exceed 3mm (0.12") in height.

- Electric drill with drill bits and customer-supplied wall anchors, flat washers, and hex nuts for flat-surface mount

If you are mounting the AP on a pipe or pole, then you will also need:

- A 25.4mm to 63.5mm (1.0" to 2.5") pipe or pole
- Two factory-supplied stainless steel clamps

## BEFORE YOU BEGIN

Before deploying Ruckus Wireless products, please check for the latest software and the release documentation.

- User Guides and Release Notes are available at <http://support.ruckuswireless.com/documents>
- Software Upgrades are available at <http://support.ruckuswireless.com/software>
- Open Source information is available at <http://opensource.ruckuswireless.com>
- Software License and Limited Warranty available at <http://support.ruckuswireless.com/warranty>

## PACKAGE CONTENTS

Before deploying your AP in the field, verify that all items listed below are included in the package. If any item is damaged or missing, notify your authorized Ruckus Wireless sales representative. Also, make sure that you have the required hardware and tools.

- One T301n AP (A in Figure 1); includes one wall- or pole-mounting bracket and one 12mm M6x1 earth ground screw with split lock and flat washers
- One M25 data cable gland (B in Figure 1)
- One green/yellow earth ground wire with ring terminal (C in Figure 1)
- Two SAE32-sized stainless steel clamps, 2.5-inch diameter (D in Figure 1)

Figure 1: AP field-installation package contents

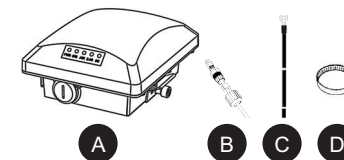

The field installation package can also include:

- Service Level Agreement/Limited Warranty Statement
- Regulatory Statement
- Registration card
- Declaration of Conformity, if required
- This *Mounting Guide*

## T301N SECTOR ANTENNA COVERAGE

The T301n 30-Degree Narrow Sector AP (ordering part number 901-T301-xx61) is best deployed where internal-antenna narrow beamforming can provide exceptional coverage to a narrow sector, or can support extended reach in a point-to-point deployment. See Figure 2 for typical internal-antenna coverage patterns and see Figure 3 for a typical high-density narrow-sector coverage pattern.

Figure 2: Typical AP narrow sector or point-to-point coverage

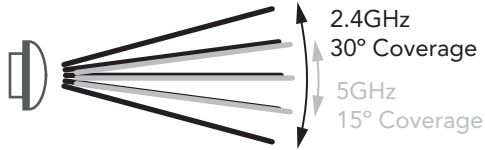

Elevation Plane Beamwidth Coverage, Side View

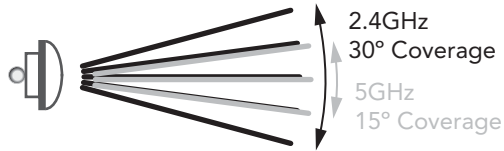

Azimuth Plane Horizontal Coverage, Top View

Figure 3: Typical AP high-density narrow-sector coverage

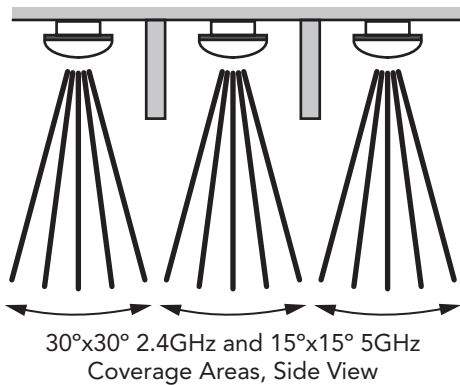

## STEP 1: CONNECTING AND SEALING THE RJ-45 CABLE

The AP uses one RJ-45 cable for Power over Ethernet (PoE). Connect and seal the cable using the M25 data cable gland (B in Figure 1).

- 1 Feed the end of the RJ-45 cable through the sealing nut (D in Figure 4), rubber sealing insert (C in Figure 4), clamping ring assembly (B in Figure 4) and cable gland base (A in Figure 4).

Figure 4: RJ-45 cable and cable gland assembly

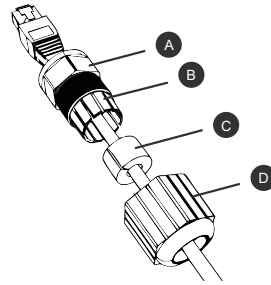

- 2 Use a wide flat-blade screwdriver to remove the blanking cap from the AP.
- 3 Connect the cable to the Ethernet port in the AP.
- 4 Tighten the cable gland base into the AP chassis to 7 N.m or 62 in-lbs.
- 5 Wrap the clamping ring assembly around the rubber sealing insert. Make sure that the clamping ring assembly fully encloses the rubber sealing insert.
- 6 Seat the clamping ring assembly and rubber sealing insert in the cable gland base.
- 7 Tighten the sealing nut to 1.1 N.m or 10 in-lbs, or until the rubber sealing insert is compressed.
- 8 Continue with [Step 2a: Attaching the Mounting Bracket to a Flat Surface](#) or [Step 2b: Attaching the Mounting Bracket to a Metal Pole](#).

## STEP 2A: ATTACHING THE MOUNTING BRACKET TO A FLAT SURFACE

- 1 The AP mounting bracket attaches to the AP using a captive screw. Use a medium flat-blade or No. 2 Phillips screwdriver to loosen the captive screw (A in Figure 5) and pull up on the end of the bracket to remove the bracket from the AP (B in Figure 5).

Figure 5: Removing the mounting bracket

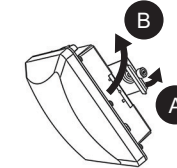

- 2 Using either of the two options shown in Figure 6, hold the mounting bracket at the location on the mounting surface where you want to mount the AP. Use the holes on the mounting bracket as a template to mark the locations of the mounting holes.

**NOTE:** The mounting bracket can be mounted to a vertical or horizontal surface to support the AP in the required orientation.

Figure 6: Mounting bracket on a flat surface

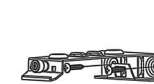

Option 1

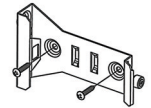

Option 2

- 3 Remove the mounting bracket from the mounting surface.
- 4 Drill holes required for the customer-supplied mounting hardware.
- 5 Attach the mounting bracket to the flat surface using the mounting hardware.
- 6 Using the mounting hardware instructions, tighten the hardware to secure the mounting bracket.
- 7 Continue with [Step 3: Mounting the AP](#).

## STEP 2B: ATTACHING THE MOUNTING BRACKET TO A METAL POLE

- 1 The AP mounting bracket attaches to the AP using a captive screw. Loosen the screw (A in Figure 5) and pull up on the end of the bracket to remove the bracket from the AP (B in Figure 5).
- 2 Insert the open end of one steel clamp (D in Figure 1) into two of the slots on the mounting bracket.

**NOTE:** The mounting bracket can be mounted to a vertical or horizontal pole to support the AP in the required orientation.

- 3 If necessary, daisy-chain the other steel clamps to accommodate larger poles.
- 4 Using either of the two options shown in Figure 7, use the clamp(s) to attach the mounting bracket to the pole. Tighten the clamps to 3 N.m or 27 in-lbs, or per manufacturer's specifications if the factory-supplied clamps are not used.

Figure 7: Mounting bracket on a pole

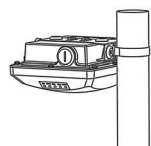

Option 1



Option 2

- 5 Continue with [Step 3: Mounting the AP](#).

## STEP 3: MOUNTING THE AP

- 1 Snap the mounting bracket back onto the AP (A in Figure 8), and use a medium flat-blade or No. 2 Phillips screwdriver to tighten the captive screw to 1.1 N.m or 10 in-lbs to secure the bracket to the AP (B in Figure 8).

Figure 8: Attaching the mounting bracket to the AP

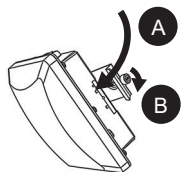

- 2 **Optional Step:** If you also need to lock the mounting bracket to the AP, then use a matching security screwdriver to screw the customer-supplied locking stainless steel 6mm M3 panhead security screw through the mounting bracket and into the AP chassis.

**CAUTION:** Make sure that the customer-supplied locking stainless steel M3 panhead security screw is no longer than 6mm. If the security screw is longer than 6mm, it can damage the AP chassis.

Figure 9: Locking the mounting bracket to the AP

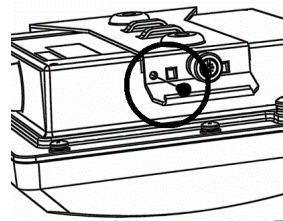

- 3 Continue with [Step 4: Earth Grounding the AP](#).

## STEP 4: EARTH GROUNDING THE AP

**CAUTION:** Make sure that earth grounding is available and that it meets local and national electrical codes. For additional lightning protection, use lightning rods and lightning arrestors.

**NOTE:** The color coding of ground wires varies by region. Before completing this step, check your local wiring standards for guidance.

- Using the factory-supplied ground wire and ground screw, connect a good earth ground to the AP chassis ground point (A in Figure 10).

**CAUTION:** The T301n AP includes one 12mm stainless steel M6x1 earth ground screw with split lock and flat washers. Make sure that any replacement screw is no longer than 12mm. If a screw is longer than 12mm, it can damage the AP chassis.

Figure 10: Connect good earth ground to AP here

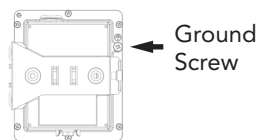

Congratulations! You have mounted your Unleashed T301n Access Point.

## Step 5: Log In and Run the Setup Wizard

**NOTE:** If you have an existing Unleashed network and you would like this AP to be part of that network, simply connect this AP via Ethernet and ensure it is in the same VLAN/subnet as the existing Unleashed network. The AP will connect to the Unleashed Master automatically, and no further configuration is required.

**NOTE:** You must ensure that your Unleashed network is running Unleashed firmware version 200.1 or later. The Unleashed T300 series APs are not supported on Unleashed firmware earlier than version 200.1.

- 1 As soon as the Unleashed AP is powered on and connected to the local network, it boots up and begins broadcasting a temporary unencrypted WLAN named “Configure.Me-[xxxxxx]” from the 2.4 GHz radio only.
- 2 Using your client’s WiFi configuration settings, select and associate to the “Configure.Me-[xxxxxx]” WLAN.
- 3 Launch a web browser and enter the following into the browser’s URL bar: [unleashed.ruckuswireless.com](http://unleashed.ruckuswireless.com), and press **Enter**.

Figure 1. Connect to the “ConfigureMe” WLAN



Figure 2. Select Create New Unleashed Network

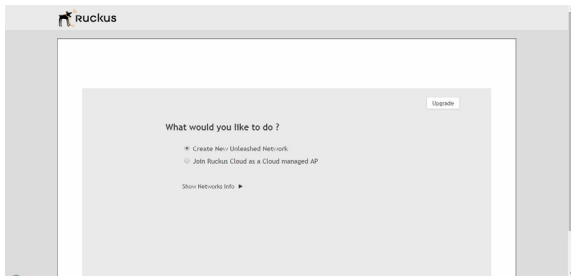

- 4 Select **Create New Unleashed Network**, and click **Start** to begin.
- 5 The “Configuring Unleashed Master” progress screen displays the progress. Wait until the initialization process completes.

**NOTE:** Do NOT disconnect the power or network cable from the device during the setup process.

- 6 Once initialization is complete, ensure that you are still connected to the “Configure.Me” WLAN, and click **Next**.
- 7 You will be redirected to the Setup Wizard. Complete the steps in the Setup Wizard and click **Finish**.

Figure 3. Complete the Setup Wizard to set up your Unleashed network

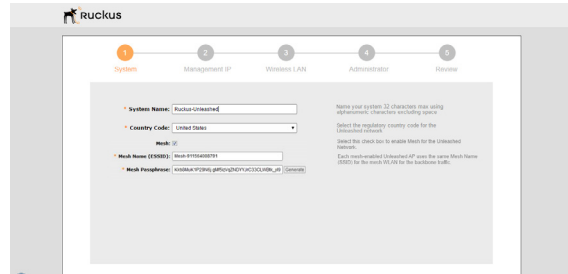

- 8 Once the Setup Wizard is finished, a “Configuring system settings and rebooting” progress screen appears. Wait until the process is complete.

Figure 4. Configuring system settings and rebooting

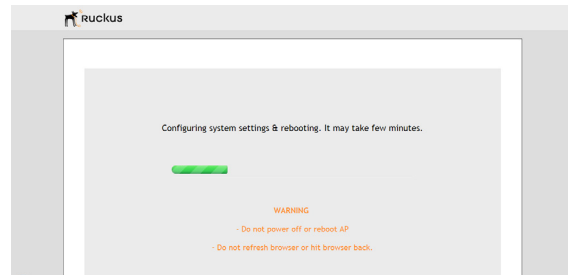

- 9 Connect to the WLAN that you configured in the Setup Wizard, and click **OK** to reconnect. You will be redirected to the [unleashed.ruckuswireless.com](http://unleashed.ruckuswireless.com) login screen.
- 10 Enter your **Admin Name** and **Password** to login.

Figure 5. The Login page

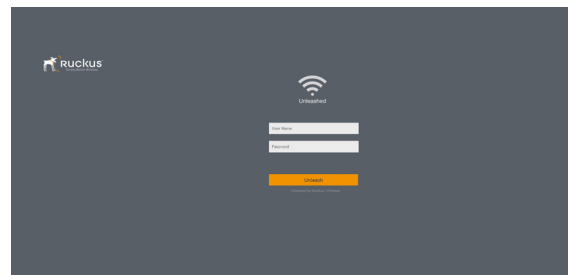

- 11 Upon successful login you will be presented with the Unleashed Dashboard, which displays an overview of your Ruckus Unleashed network.

Figure 6. : The Unleashed Dashboard

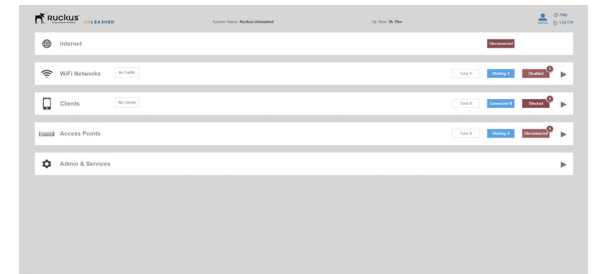

## STEP 6: CUSTOMIZE YOUR WIRELESS LANs

Once the Unleashed Master AP has been initialized, you can fine-tune the settings of your first WLAN (that you created during the setup wizard), and create any additional WLANs needed prior to attaching additional Unleashed member APs. Then, when you deploy additional member APs in whatever order you prefer, they will automatically retrieve all WLAN configuration settings (and any other settings you have configured) from the Unleashed Master AP.

- 1 From the Dashboard, click anywhere in the WiFi Networks section to expand the display of your deployed WLANs.
- 2 On the left side of the screen, select the WLAN box for the WLAN you would like to configure, and click the **Edit** button to edit the configuration; or click **Create** to create a new WLAN.
- 3 If you made any changes to the original WLAN, you will be disconnected and will need to reconnect once the changes have been deployed on the AP radios.

Congratulations! Your Unleashed network is now configured and ready for use. You may now proceed to [Step 7: Deploy Additional Unleashed Access Points](#).

## STEP 7: DEPLOY ADDITIONAL UNLEASHED ACCESS POINTS

Deploying additional Unleashed member APs is simply a matter of connecting them to the same Layer 2 network (subnet) and providing power. They will discover the Unleashed Master and join automatically. No additional steps are necessary.

## FOR MORE INFORMATION

For more information on managing your Unleashed network, refer to the *Ruckus Wireless Unleashed Online Help*, available from within the Unleashed user interface.